

PULSATION DAMPENER / SUPPRESSOR SERIES PDS PROVIDES MULTIPLE SYSTEM SAFEGUARDS



FUNCTIONS:

1. Pulsation Dampener smooths pump flow
2. Surge Suppressor absorbs shocks and vibrations
3. Water Hammer Arrestor eliminates dangerous pressure spikes from quick closing valves
4. Inlet Stabilizer enhances pump performance and longevity
5. Accumulator releases stored fluid during unwanted pressure drops
6. Expansion Tank protects system from thermal volume increases

DESIGN FEATURES:

- Large inlet improves response
- Inlet screen protects bladder with minimal flow obstruction
- Dual seal channels protect against air and system leaks
- Top quality thermoplastics and elastomers resist chemical attack, protect system purity
- No wetted metal parts
- Up to 150 PSI working pressure (excluding pressure spikes)

DESCRIPTION:

PDS is available in three capacities/sizes: 10 cubic inch capacity with a 1" NPT process connection, 50 cubic inch capacity with a 2" NPT process connection, and 180 cubic inch capacity with a 3" NPT process connection. Body materials are choice of Geon PVC, CPVC, Natural Polypropylene, or Kynar PVDF. Inlet screen and dome top match selected body material. Bladder material is EPDM or FKM. Air inlet valve and gauge isolation valve (non-wetted) are brass. Fasteners are stainless steel.

For other material or connection requirements, please consult factory.

HOW IT WORKS:

Pulsation Dampener and Surge Suppressor will steady a pulsing flow caused by diaphragm pumps, piston pumps, peristaltic pumps and other quick flow interrupting equipment. When used properly, quick pulsating flows will be greatly reduced preventing a number of flow control problems.

Pulsation dampening provides the added benefit of smoothing the output supplied by many types of pumps, especially double diaphragm pumps. The PDS will steady a vibrating pointer of a pressure gauge or flow meter under flowing conditions. This provides a steady, uninterrupted supply to points of use, which will greatly enhance system productivity, prolong pump life, and prevent splashing and foaming.

Water Hammer Arrestor When used properly, water hammer will be greatly reduced and prevent pipe vibration and leaking connections, damage to valves and filters, ruptured tanks and other equipment damage, as per the Plumbing and Drainage Institute Standard PDI-WH 201.

Inlet Stabilizer ensures a continuous supply of liquid to the pump, reducing strain on the pump and greatly improving efficiency and eliminating cavitation.

Accumulator liquid and pressure can be held for unexpected power outages or other system failures, and then used to complete a cycle, retained for backflush during scheduled maintenance, or any other requirements when the regular process is off or interrupted.

Thermal Expansion Tank The PDS can be used as a simple expansion tank in many applications where anticipated expansion would be less than the stated capacity of the unit.

Important: Please note that Series PDS is designed to operate as a pressurized vessel. Proper precaution

should be taken to ensure safe installation and operation; read the installation instructions carefully prior to use. The unit should be charged with regulated compressed air or nitrogen only. Oxygen must not be used. The gauge isolation valve should be closed prior to opening the system connection valve. Failure to observe all precautions could result in system failure, leaks, explosion, property damage, personal injury and/or fatalities.

SIZING THE PDS

Selecting a PDS Dampener(s) with sufficient capacity or volume is determined by a number of factors depending on the application; please refer to the following selection tables. The suitability of the PDS as defined by these tables may not be appropriate for every application for a variety of factors, including but not limited to liquid velocity, presence of entrained air or gas in the pipeline, distance from pump or quick closing valves, specific gravity and/or liquid viscosity, temperature, variances in pressure, and a host of other factors. For applications in question, please contact our Technical Team at 1+ 973-256-3000.

INSTALLATION NOTES

The sizing charts provided are general guidelines. If the dampening in a particular system is not sufficient, an additional or larger unit may be required to meet the requirements of a particular system. POM dampeners, water hammer arrestors, and inlet stabilizers have inlet ports larger than other competitors to transfer fluid and forces faster. This allows slightly smaller and lighter units to be used as opposed to larger and heavier ones.

In all cases a blocking valve should be installed between the PDS unit and the piping tee; see instructions. Installation tee should be one pipe size larger than the system to facilitate pressure transfer, installed as close as possible to the application need.

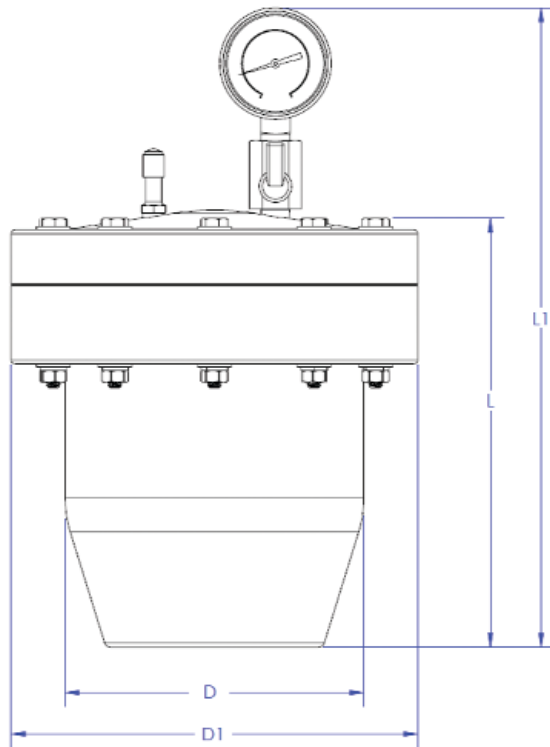

MODEL	CONNECTION SIZE	CAPACITY IN CUBIC INCHES	D		D		L		L1	
			N.	MM.	IN.	MM.	IN.	MM.	IN.	MM.
PDS010EPT-PV	1"	10	3.60	91.4	5.00	127.0	5.40	137.2	9.20	233.7
PDS050EPT-PV	2"	50	5.50	139.7	7.50	190.5	7.90	200.7	11.80	299.7
PDS180EPT-PV	3"	180	7.70	195.6	9.90	251.5	11.40	289.6	15.30	388.6

- For FKM seals, use "V" for example PDS010VT-PV; for EPDM seals use "EP" as shown above.
- Standard connections are threaded and indicated by the "T" after the seal material.
- For CPVC body, use "-CP" for example PDS010VT-CP; for Natural Polypro use "PP", for Kynar PVDF use "PF". For PVC body use "-PV" as shown above.
- For optional gauges, connections or materials please consult factory.

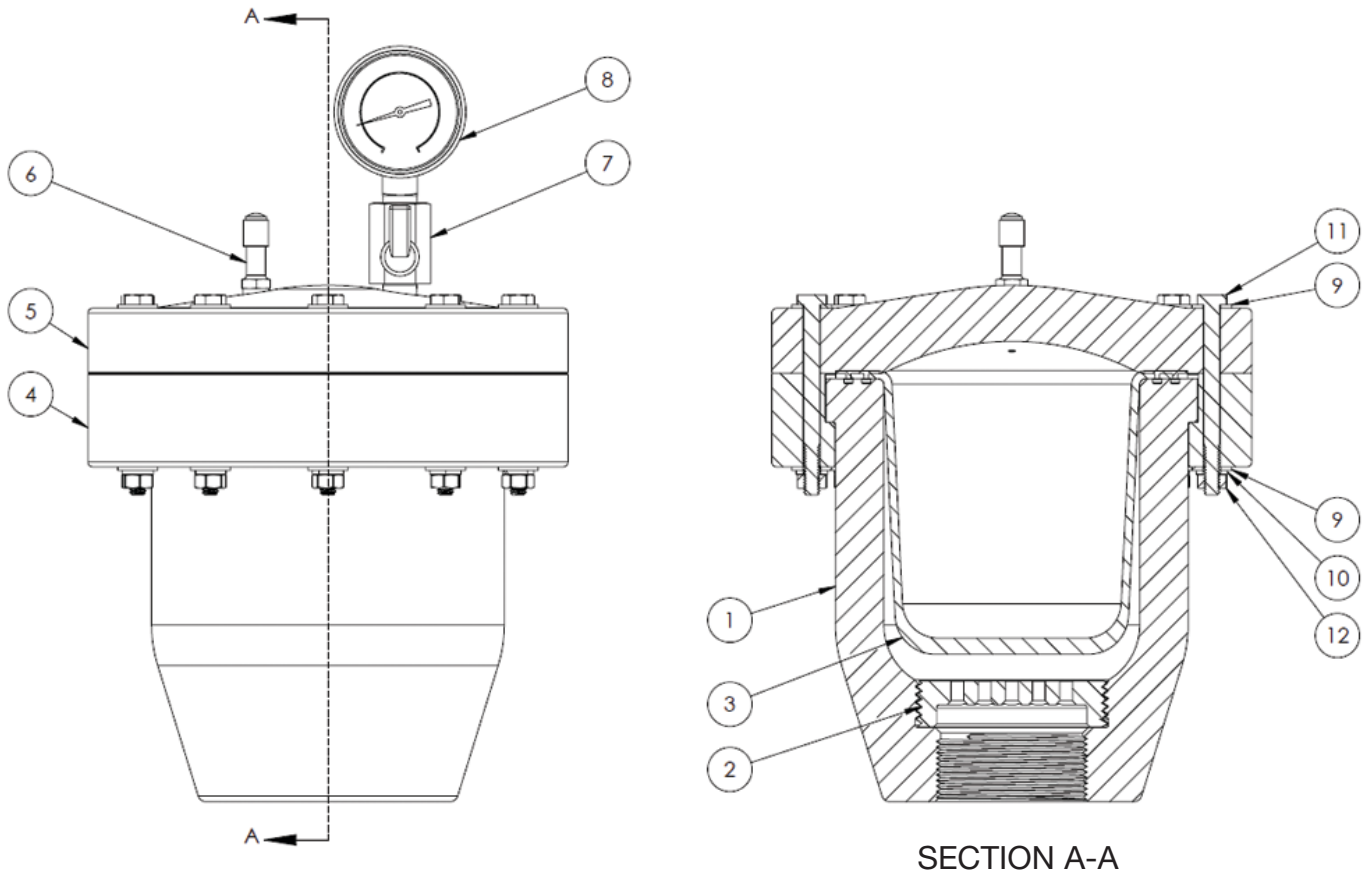

ITEM NO.	DESCRIPTION
1	BULB BODY
2	INLET SCREEN
3	BLADDER
4	CLAMP RING
5	DOMES TOP
6	AIR INLET VALVE, PDS
7	GAUGE ISOLATION VALVE, PDS
8	0-160 PSI PRESSURE GAUGE, LOWER MOUNT
9	STAINLESS FLAT WASHER
10	SS LOCKWASHER
11	SS CAP SCREW HEX HEAD
12	SS HEX NUT



WATER HAMMER ARRESTOR SELECTION CHART

ALL FLOW RATES ARE FOR 5 FEET / SECOND

SCD. 80 PIPE DIA.	LENGTH OF PIPE (FEET)	FLOW RATE (GAL. / MIN.)	RECOMMENDED POM DAMPENER	
			60 PSI LINE PRESSURE	100 PSI LINE PRESSURE
1/4"	25	1.02	PDS010	PDS010
1/4"	50	1.02	PDS010	PDS010
1/4"	100	1.02	PDS010	PDS010
1/4"	200	1.02	PDS010	PDS010
3/8"	25	2.03	PDS010	PDS010
3/8"	50	2.03	PDS010	PDS010
3/8"	100	2.03	PDS010	PDS010
3/8"	200	2.03	PDS010	(2) PDS010
1/2"	25	3.41	PDS010	PDS010
1/2"	50	3.41	PDS010	PDS010
1/2"	100	3.41	PDS010	(2) PDS010
1/2"	200	3.41	PDS010	PDS050
3/4"	25	6.42	PDS010	PDS010
3/4"	50	6.42	PDS010	(2) PDS010
3/4"	100	6.42	PDS010	PDS050
3/4"	200	6.42	(2) PDS10	PDS050
1"	25	10.7	PDS010	PDS010
1"	50	10.7	PDS010	(2) PDS010
1"	100	10.7	(2) PDS010	PDS050
1"	200	10.7	PDS050	(2) PDS050
1-1/2"	25	26.67	PDS010	PDS050
1-1/2"	50	26.67	(2) PDS010	PDS050
1-1/2"	100	26.67	PDS050	(2) PDS050
1-1/2"	200	26.67	(2) PDS050	PDS180
2"	25	44.8	(2) PDS010	PDS050
2"	50	44.8	PDS050	(2) PDS050
2"	100	44.8	(2) PDS050	PDS180
2"	200	44.8	PDS180	PDS180 + PDS050

Note that (1) PDS050 can be used instead of (2) PDS010 water hammer arrestors.

Note that (1) PDS180 can be used instead of (2) PDS050 water hammer arrestors.

Always set bladder preload pressure at 5 psi less than line pressure when flowing.

For flow parameters not listed consult factory.

SIZING CHART FOR PULSATION DAMPENING

PERISTALTIC PUMP

PORT SIZE	(HOSE PUMP) GALLONS PER REVOLUTION	RECOMMENDED POM DAMPENERS
1/4"	UP TO 0.010	PDS010
3/8"	UP TO 0.010	PDS010
1/2"	UP TO 0.010	PDS010
3/4"	UP TO 0.025	PDS050
1"	UP TO 0.075	PDS050
1-1/2"	UP TO 0.4	PDS180
2"	UP TO 0.9	(2)PDS180

AIR OPERATED DOUBLE DIAPHRAGM PUMP

PORT SIZE	RECOMMENDED POM DAMPENERS
1/4"	PDS010
3/8"	PDS010
1/2"	PDS050
3/4"	PDS050
1"	PDS050
-1/4"	PDS180
1-1/2"	PDS180
2"	(2) PDS180

SINGLE ACTING PISTON METERING PUMP

PORT SIZE	MINIMUM PUMP CYCLES PER MINUTE	MINIMUM REQUIRED BACK PRESSURE PSI	VOLUME PER STROKE GPM	RECOMMENDED POM DAMPENERS
1/4"	40	27	0.03	PDS010
1/4"	40	35	0.037	PDS010
1/4"	30	30	0.024	PDS010
1/4"	20	20	0.062	(2) PDS010
1/4"	15	25	0.076	(2) PDS010
3/8"	40	25	0.075	(2) PDS010
3/8"	30	25	0.066	(2) PDS010
3/8"	20	30	0.086	(2) PDS010
1/2"	30	15	0.085	PDS050
1/2"	30	12	0.09	PDS050
1/2"	15	15	0.085	PDS050
1/2"	6	8	0.085	PDS050
3/4"	30	15	0.12	PDS050
3/4"	30	12	0.2	(2) PDS050
3/4"	15	10	0.25	(2) PDS050
3/4"	6	15	0.32	(2) PDS050
1"	30	15	0.12	PDS050
1"	15	10	0.25	(2) PDS050
1"	6	15	0.32	(2) PDS050
1-1/2"	24	15	0.19	(2) PDS050
1-1/2"	18	10	0.32	PDS180
1-1/2"	12	16	0.41	PDS180
2"	24	10	0.28	PDS180
2"	16	14	0.33	PDS180
2"	10	17	0.548	(2) PDS180

ONE PDS050 UNIT CAN BE USED INSTEAD OF 2 PDS010 UNITS AND ONE PDS180 CAN BE USED INSTEAD OF 2 PDS050 UNITS.

NOTE THAT "MINIMUM PUMP CYCLES", "MINIMUM BACK PRESSURE", AND "VOLUME" RECOMMENDATIONS ARE FOR NEAR SMOOTH OUTLET FLOW CONDITIONS.

AS A GENERAL RULE, THESE CHARTS WILL ELIMINATE APPROXIMATELY 75% OF TYPICAL PULSATIONS. FOR GREATER REDUCTIONS, USE THE FORMULA PROVIDED AT PLASTOMATIC.COM.

ALWAYS SET BLADDER PRELOAD PRESSURE AT 5 PSI LESS THAN LINE PRESSURE WHEN FLOWING.